



## MOVE IT PRO system

trimless

**EN** Extruded aluminium profile with 45 mm width and 55 mm height; for trimless installation in 12.5 mm plasterboard ceilings; designed for continuous lighting systems, L / T / X connectors for flexible system design; with integrated 3-phase copper conductors + 4 emergency lighting copper conductors (2 emergency lighting circuits) + 2 DALI copper conductors for take off of supply voltage, emergency lighting power supply and DALI signal; customcut possible; surface powder coated; insets, incl. high power adapter + converter can be installed flexibly and without tools; light inserts with different patterns of light distribution, emergency light inserts (escape sign and emergency luminaires) for operation on a central battery system and sensor inserts can be integrated

**DE** Aluminiumstrangpressprofil mit 45 mm Breite und 55 mm Höhe; für randlosen Einbau in 12,5 mm Gipskartondecken; ausgelegt für durchgehende Lichtsysteme, L- / T- / X-Verbinder für flexiblen Systemaufbau; mit integrierten 3-Phasen Kupferleitern + 4 Notlicht-Kupferleitern (2 Notlichtkreise) + 2 DALI-Kupferleitern für Abnahme von Versorgungsspannung, Notlicht-Spannungsversorgung und DALI Signal; auf Kundenwunsch ablängbar; Oberfläche pulverbeschichtet; flexible und werkzeuglose Montage der Einsätze, inkl. High Power Adapter + Konverter; Leuchteinsätze mit unterschiedlichen Abstrahlcharakteristiken, Notlichteinsätze (Rettungszeichen- und Sicherheitsleuchten) für den Betrieb an einer Zentralbatterieanlage und Sensor-Einsätze integrierbar

### Quickinfo

DALI-2

### Types

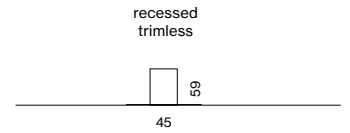

connectors



L-connector

T-connector

X-connector

### Colours



up to 192lm/W  
(high efficiency)

## Order options

### CONTROL

DALI-2

### MATERIAL COLOUR

- jet black RAL 9005 8
- traffic white RAL 9016 7



## MOVE IT PRO trimless

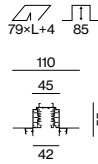
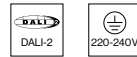

### INSTALLATION TRACK 220 V – 250 V / 440 V | EM 220 V – 250 V

L (mm)		ORDER CODE
1000	channel	086-512113 <input checked="" type="checkbox"/>
2000	channel	086-512213 <input checked="" type="checkbox"/>
3000	channel	086-512313 <input checked="" type="checkbox"/>
4000	channel	086-512413 <input checked="" type="checkbox"/>
custom cut	channel	E83810 ···· <input checked="" type="checkbox"/>

## Pole options

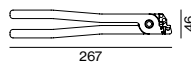
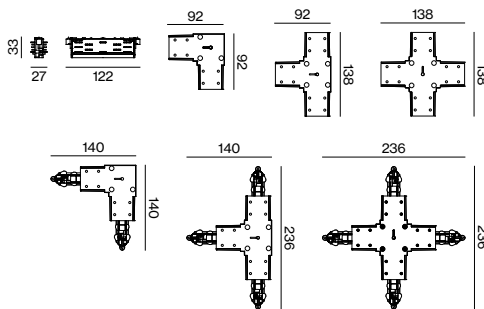
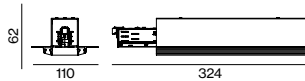
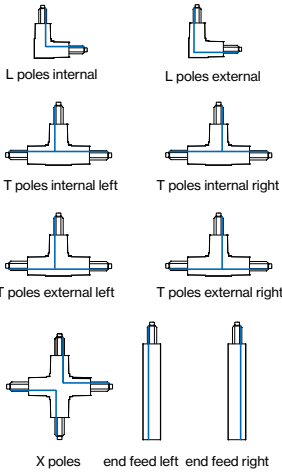

## Accessories

### END CAPS

TYPE	ORDER CODE
end cap	086-522011 <input checked="" type="checkbox"/>

### BLIND COVER

L (mm)	ORDER CODE
25000	blind cover <span style="float: right;">086-608250 <input checked="" type="checkbox"/></span>

### POWER FEEDER WITH EMERGENCY CONDUCTORS

supply 220-250V/440V | EM 220-250V

TYPE	ORDER CODE
end feed poles right	086-522313 <input checked="" type="checkbox"/>
end feed poles left	086-522413 <input checked="" type="checkbox"/>
middle feed	086-522323 <input checked="" type="checkbox"/>

### POWER FEEDER WITHOUT EMERGENCY CONDUCTORS

supply 220-250V/440V

TYPE	ORDER CODE
intrack feed	086-5213338

### CONNECTORS

TYPE	ORDER CODE
linear connector electrical	086-5211138
L-connector poles external	086-522133 <input checked="" type="checkbox"/>
L-connector poles internal	086-522233 <input checked="" type="checkbox"/>
L-connector mechanical	086-522230 <input checked="" type="checkbox"/>
T-connector poles internal   right	086-522143 <input checked="" type="checkbox"/>
T-connector poles internal   left	086-522243 <input checked="" type="checkbox"/>
T-connector poles external   right	086-522173 <input checked="" type="checkbox"/>
T-connector poles external   left	086-522273 <input checked="" type="checkbox"/>
T-connector (mechanical)	086-522240 <input checked="" type="checkbox"/>
X-connector	086-522153 <input checked="" type="checkbox"/>
X-connector (mechanical)	086-522150 <input checked="" type="checkbox"/>

### MOUNTING ACCESSORIES

TYPE	ORDER CODE
mechanical linear connector (pair)	050-2011110
conductors cutting tool	086-5219110

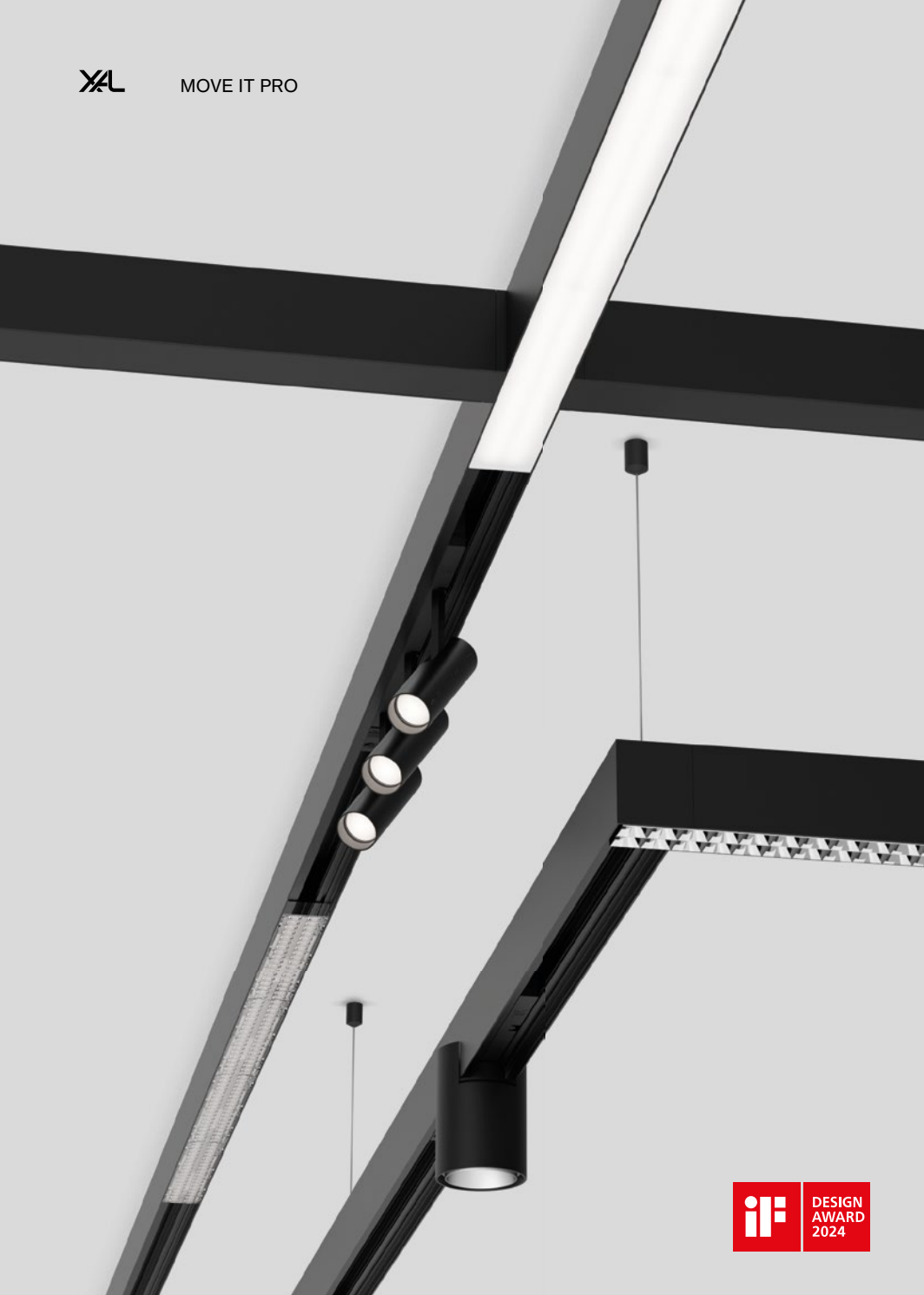

## MOVE IT PRO system

surface/suspended

**EN** Extruded aluminium profile with 45 mm width and 59 mm height; for ceiling surface mounting or suspended mounting (cable suspension); height adjustment without tools; designed for continuous lighting systems, L / T / X connectors for flexible system design; with integrated 3-phase copper conductors + 4 emergency lighting copper conductors (2 emergency lighting circuits) + 2 DALI copper conductors for take off of supply voltage, emergency lighting power supply and DALI signal; customcut possible; surface powder coated; insets, incl. high power adapter + converter can be installed flexibly and without tools; light inserts with different patterns of light distribution, emergency light inserts (escape sign and emergency luminaires) for operation on a central battery system and sensor inserts can be integrated

**DE** Aluminiumstrangpressprofil mit 45 mm Breite und 59 mm Höhe; für Deckenanbaumontage oder für abgehängte Montage (Seilabhängung); werkzeuglose Höhenverstellung; ausgelegt für durchgehende Lichtsysteme, L- / T- / X-Verbinder für flexiblen Systemaufbau; mit integrierten 3-Phasen Kupferleitern + 4 Notlicht-Kupferleitern (2 Notlichtkreise) + 2 DALI-Kupferleitern für Abnahme von Versorgungsspannung, Notlicht-Spannungsversorgung und DALI Signal; auf Kundenwunsch ablängbar; Oberfläche pulverbeschichtet; flexible und werkzeuglose Montage der Einsätze, inkl. High Power Adapter + Konverter; Lichteinsätze mit unterschiedlichen Abstrahlcharakteristiken, Notlichteinsätze (Rettungszeichen- und Sicherheitsleuchten) für den Betrieb an einer Zentralbatterieanlage und Sensor-Einsätze integrierbar

### Quickinfo

DALI-2

### Types

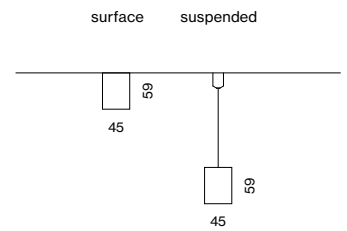

connectors

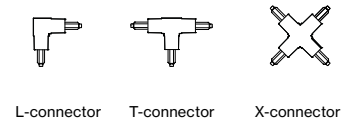

Colours



up to 192 lm/W  
(high efficiency)

## Order options

### CONTROL

DALI-2

### MATERIAL COLOUR

- jet black RAL 9005 8
- traffic white RAL 9016 7

### MATERIAL COLOUR

#### CABLE SUSPENSION

- black 8
- chrome 0



## MOVE IT PRO surface/suspended



### INSTALLATION TRACK 220 V – 250 V / 440 V | EM 220 V – 250 V

L (mm)	TYPE	ORDER CODE
1000	channel	086-511113
2000	channel	086-511213
3000	channel	086-511313
4000	channel	086-511413
custom cut	channel	E83820

## Accessories

### END CAPS

TYPE	ORDER CODE
end cap	086-521011

### BLIND COVER

L (mm)	TYPE	ORDER CODE
25000	blind cover	086-608250

### POWER FEEDER WITH EMERGENCY CONDUCTORS

supply 220-250V/440V | EM 220-250V

TYPE	ORDER CODE
end feed poles right	086-521413
end feed poles left	086-521313
middle feed	086-521323

### POWER FEEDER WITHOUT EMERGENCY CONDUCTORS

supply 220-250V/440V

TYPE	ORDER CODE
intrack feed	086-5213338

## Pole options

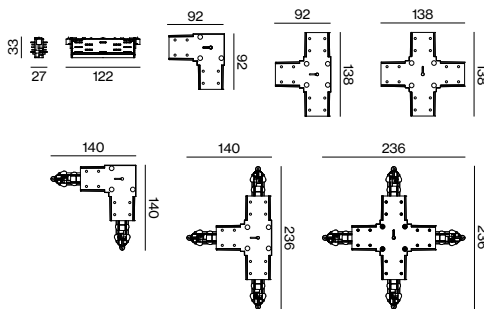
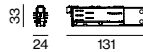
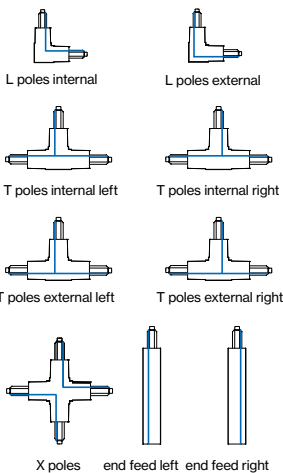

### CONNECTORS

TYPE	ORDER CODE
linear connector electrical	086-5211138
L-connector poles external	086-521133
L-connector poles internal	086-521233
L-connector mechanical	086-521230
T-connector poles internal   right	086-521143
T-connector poles internal   left	086-521243
T-connector poles external   right	086-521173
T-connector poles external   left	086-521273
T-connector (mechanical)	086-521240
X-connector	086-521153
X-connector (mechanical)	086-521150

### MOUNTING ACCESSORIES

TYPE	ORDER CODE
ceiling fastener	086-521511
suspension bracket	086-521521
linear suspension connector (mechanical)	086-521531
conductors cutting tool	086-5219110
drilling template for indirect inset	086-5219510

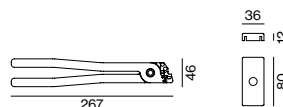
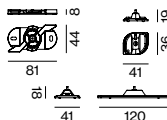

### CABLE SUSPENSION

TYPE	L (mm)	ORDER CODE
cable suspension	1500	086-521711
cable suspension	3000	086-521721
cable suspension	6000	086-521731
connector cable suspension	1500	058-301811
connector cable suspension	3000	058-301821
connector cable suspension	6000	058-301831
tool for connector cable suspension		050-2049210

## Quickinfo

2700 K, 3000 K, 3500 K, 4000 K  
 CRI  $\geq$  80, CRI  $\geq$  90, 3 SDCM  
 UGR  $\leq$  19 / 65°  $\leq$  1500 cd/m<sup>2</sup>  
 up to 187 lm/W  
 up to 2940 lm/m  
 L90 @ 50 000 h  
 DALI-2

## Types

louver

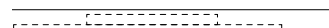

## Colours



## Light distribution



super  
wide  
flood



# LOUVER

linear inset

<sup>EN</sup> Linear light inset made of plastic; light inset, incl. high power adapter + converter can be installed flexibly and without tools; flush with profile system; high quality reflector with micro-faceted, aluminum-vaporised surface; precise radiation characteristic with symmetrical light distribution; for use in schools and offices; energy-efficient LEDs with very good colour rendering

<sup>DE</sup> Linear-Lichteinsatz aus Kunststoff; Lichteinsatz, inkl. High Power Adapter + Konverter, werkzeuglos einsetz- und verschiebbar; bündig im Profilsystem; hochwertiger Reflektor mit mikrofaccettierter, aluminiumbedampfter Oberfläche; präzise Abstrahlcharakteristik mit symmetrischer Lichtverteilung; für den Einsatz in Schulen und im Bürobereich; energieeffiziente LEDs mit sehr guter Farbwiedergabe

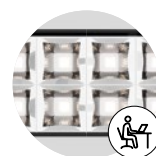

DIN EN 12464-1  
UGR  $\leq$  19



up to 187 lm/W  
(high efficiency)

## Order options

### COLOUR TEMPERATURE

2700K CRI ≥ 90	9
3000K CRI ≥ 90	0
3500K CRI ≥ 90	2
4000K CRI ≥ 90	1
2700K CRI ≥ 80	4
3000K CRI ≥ 80	5
3500K CRI ≥ 80	7
4000K CRI ≥ 80	6

### CONTROL

DALI-2

### LIGHT OPTIC

super wide flood 74°

### MATERIAL COLOUR

chrome reflector	4
black reflector	8

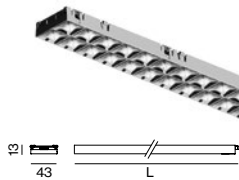

## LOUVER inset



### REFLECTOR WIDE

SYSTEM POWER	COLOUR TEMP.	LUM. FLUX	L (mm)	ORDER CODE
16.7W	2700K	2580lm	1000	0 8 6 - 6 4 1 0 :: 3 X
	3000K	2580lm		
	3500K	2760lm		
	4000K	2940lm		
25.1W	2700K	3870lm	1500	0 8 6 - 6 4 2 0 :: 3 X
	3000K	3870lm		
	3500K	4140lm		
	4000K	4400lm		
33W	2700K	5160lm	2000	0 8 6 - 6 4 3 0 :: 3 X
	3000K	5160lm		
	3500K	5520lm		
	4000K	5870lm		
42W	2700K	6450lm	2500	0 8 6 - 6 4 4 0 :: 3 X
	3000K	6450lm		
	3500K	6890lm		
	4000K	7340lm		
47W	2700K	7740lm	3000	0 8 6 - 6 4 5 0 :: 3 X
	3000K	7740lm		
	3500K	8270lm		
	4000K	8810lm		

## Quickinfo

2700 K, 3000 K, 3500 K, 4000 K  
 CRI ≥ 80, CRI ≥ 90, 3 SDCM  
 up to 162 lm/W  
 up to 4960 lm/m  
 L90 @ 50 000 h  
 DALI-2

## Types

shelf floor washer

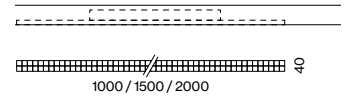

wallwasher

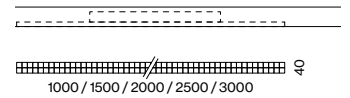

## Colours



## Light distributions



shelf floor washer 1-sided    shelf floor washer 2-sided    wall washer 1-sided



# SHELF FLOOR WASHER

linear inset

**EN** Linear light inset made of plastic; light inset, incl. high power adapter + converter can be installed flexibly and without tools; flush with profile system; high quality reflector with micro-faceted, aluminum-vaporised surface; with special, multi-free-form, facet effect surface reflectors for high precision light control; precise shelf and aisle zone lighting, optimum longitudinal glare control for high viewing comfort in the aisle zone; for use in grocery and fashion; energy-efficient LEDs with very good colour rendering

**DE** Linear-Lichteinsatz aus Kunststoff; Lichteinsatz, inkl. High Power Adapter + Konverter, werkzeuglos einsetz- und verschiebbar; bündig im Profilsystem; hochwertiger Reflektor mit mikrofaccettierter, aluminiumbedampfter Oberfläche; mit speziellen Multi-Freiformflächenreflektoren mit Facettenoptik zur äußerst präzisen Lichtlenkung; punktgenaue Regal- und Gangzonenausleuchtung, optimale Längsentblendung für hohen Sehkomfort in der Gangzone; für den Einsatz im Lebensmittelhandel und Fashionbereich; energieeffiziente LEDs mit sehr guter Farbwiedergabe



glare-free reflector  
longitudinally



precision  
cut-off



up to 162 lm/W  
(high efficiency)

### Order options

#### COLOUR TEMPERATURE ◆◆

2700 K CRI ≥ 90	9
3000 K CRI ≥ 90	0
3500 K CRI ≥ 90	2
4000 K CRI ≥ 90	1
2700 K CRI ≥ 80	4
3000 K CRI ≥ 80	5
3500 K CRI ≥ 80	7
4000 K CRI ≥ 80	6

#### CONTROL

DALI-2

#### LIGHT OPTIC ▲

shelf / floor washer single	W
shelf / floor washer	Y
wallwasher	

#### MATERIAL COLOUR ▣

chrome reflector	4
black reflector	8

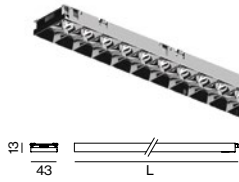

### SHELF FLOOR WASHER inset

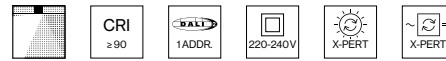

#### SHELF / FLOOR WASHER LOW POWER

SYSTEM POWER	COLOUR TEMP.	LUM. FLUX	L (mm)	ORDER CODE
22.1W	3000K	2960lm	1000	0 8 6 - 6 6 1 0 :: 3 ▣ ▲
	4000K	3370lm		
33.1W	3000K	4440lm	1500	0 8 6 - 6 6 2 0 :: 3 ▣ ▲
	4000K	5050lm		
42W	3000K	5930lm	2000	0 8 6 - 6 6 3 0 :: 3 ▣ ▲
	4000K	6740lm		

#### SHELF / FLOOR WASHER HIGH POWER

SYSTEM POWER	COLOUR TEMP.	LUM. FLUX	L (mm)	ORDER CODE
32W	3000K	4360lm	1000	0 8 6 - 6 6 1 5 :: 3 ▣ ▲
	4000K	4960lm		
48W	3000K	6540lm	1500	0 8 6 - 6 6 2 5 :: 3 ▣ ▲
	4000K	7440lm		

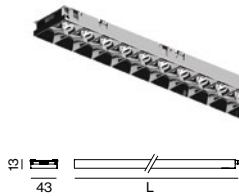

### WALLWASHER inset



#### REFLECTOR WALLWASHER

SYSTEM POWER	COLOUR TEMP.	LUM. FLUX	L (mm)	ORDER CODE
16.5W	3000K	2180lm	1000	0 8 6 - 6 4 1 0 :: 3 ▣ ▲
	4000K	2490lm		
24.8W	3000K	3280lm	1500	0 8 6 - 6 4 2 0 :: 3 ▣ ▲
	4000K	3730lm		
33W	3000K	4370lm	2000	0 8 6 - 6 4 3 0 :: 3 ▣ ▲
	4000K	4980lm		
41W	3000K	5460lm	2500	0 8 6 - 6 4 4 0 :: 3 ▣ ▲
	4000K	5220lm		
47W	3000K	6550lm	3000	0 8 6 - 6 4 5 0 :: 3 ▣ ▲
	4000K	7470lm		



## Quickinfo

3000 K, 3500 K, 4000 K  
 CRI  $\geq$  80, CRI  $\geq$  90, 3 SDCM  
 UGR  $\leq$  19  
 up to 192 lm/W  
 up to 2940 lm/m  
 L90 @ 50 000 h  
 DALI-2

## Types

lens

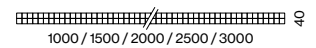
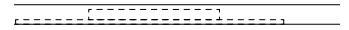

## Colour



## Light distribution



wide  
flood



## LENS

linear inset

<sup>EN</sup> Linear light inset made of plastic; light inset, incl. high power adapter + converter can be installed flexibly and without tools; flush with profile system; equipped with specially computed wide beam lenses; precise radiation characteristic with symmetrical light distribution; for use in schools and offices; energy-efficient LEDs with very good colour rendering

<sup>DE</sup> Linear-Lichteinsatz aus Kunststoff; Lichteinsatz, inkl. High Power Adapter + Konverter, werkzeuglos einsetz- und verschiebbar; bündig im Profilsystem; bestückt mit speziell berechneten wide beam Linsen; präzise Abstrahlcharakteristik mit symmetrischer Lichtverteilung; für den Einsatz in Schulen und im Bürobereich; energieeffiziente LEDs mit sehr guter Farbwiedergabe



DIN EN 12464-1  
UGR  $\leq$  19



up to 192 lm/W  
(high efficiency)

### Order options

**COLOUR TEMPERATURE** ⦿

3000 K CRI ≥ 90	0
3500 K CRI ≥ 90	2
4000 K CRI ≥ 90	1
3000 K CRI ≥ 80	5
3500 K CRI ≥ 80	7
4000 K CRI ≥ 80	6

**CONTROL**

DALI-2

**LIGHT OPTIC**

wide flood 68°

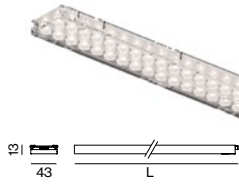

### LENS inset



### LENS WIDE

SYSTEM POWER	COLOUR TEMP.	LUM. FLUX	L (mm)	ORDER CODE
16.6W	3000K	2590lm	1000	0 8 6 - 6 7 1 0 ⦿ 30 W
	3500K	2770lm		
	4000K	2940lm		
24.8W	3000K	3880lm	1500	0 8 6 - 6 7 2 0 ⦿ 30 W
	3500K	4150lm		
	4000K	4420lm		
32W	3000K	5170lm	2000	0 8 6 - 6 7 3 0 ⦿ 30 W
	3500K	5530lm		
	4000K	5890lm		
40W	3000K	6470lm	2500	0 8 6 - 6 7 4 0 ⦿ 30 W
	3500K	6910lm		
	4000K	7360lm		
46W	3000K	7760lm	3000	0 8 6 - 6 7 5 0 ⦿ 30 W
	3500K	8300lm		
	4000K	8830lm		

**Quickinfo**

2700 K, 3000 K, 3500 K, 4000 K  
 CRI ≥ 80, CRI ≥ 90, 3 SDCM  
 up to 163 lm/W  
 up to 2590 lm/m  
 L90 @ 50 000 h  
 DALI-2

**Types**

lens wallwasher

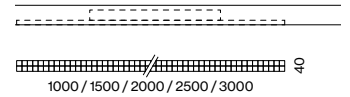
**Colour****Light distribution**

wall  
wash.

**LENS**

linear inset

**EN** Linear light inset made of plastic; light inset, incl. high power adapter + converter can be installed flexibly and without tools; flush with profile system; equipped with specially computed wallwasher lenses; precise radiation characteristic with asymmetrical light distribution; energy-efficient LEDs with very good colour rendering

**DE** Linear-Lichteinsatz aus Kunststoff; Lichteinsatz, inkl. High Power Adapter + Konverter, werkzeuglos einsetz- und verschiebbar; bündig im Profilsystem; bestückt mit speziell berechneten wallwasher Linsen; präzise Abstrahlcharakteristik mit asymmetrischer Lichtverteilung; energieeffiziente LEDs mit sehr guter Farbwiedergabe



up to 190 lm/W  
(high efficiency)

## Order options

### COLOUR TEMPERATURE

2700 K CRI ≥ 90	9
3000 K CRI ≥ 90	0
3500 K CRI ≥ 90	2
4000 K CRI ≥ 90	1
2700 K CRI ≥ 80	4
3000 K CRI ≥ 80	5
3500 K CRI ≥ 80	7
4000 K CRI ≥ 80	6

### CONTROL

DALI-2

### LIGHT OPTIC



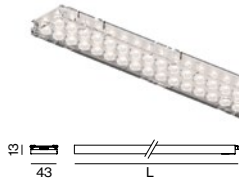

wallwasher



## LENS inset



## LENS WALLWASHER

SYSTEM POWER	COLOUR TEMP.	LUM. FLUX	L (mm)	ORDER CODE
16.4W	3000K	2270lm	1000	0 8 6 - 6 7 1 0  30 A
24.6W	4000K	2590lm	1500	0 8 6 - 6 7 2 0  30 A
	3000K	3330lm		
32.8W	4000K	3790lm	2000	0 8 6 - 6 7 3 0  30 A
	3000K	4440lm		
41W	4000K	5050lm	2500	0 8 6 - 6 7 4 0  30 A
	3000K	5550lm		
46W	4000K	6310lm	3000	0 8 6 - 6 7 5 0  30 A
	3000K	6650lm		
	4000K	7580lm		

## Quickinfo

2700 K, 3000 K, 3500 K, 4000 K  
 CRI  $\geq$  80, CRI  $\geq$  90, 3 SDCM  
 UGR  $\leq$  16, 19 / 65°  $\leq$  1500 cd/m<sup>2</sup>  
 up to 179 lm/W  
 up to 2800 lm/m  
 L90 @ 50 000 h  
 DALI-2

## Types

spot line

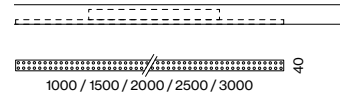

## Colours



## Light distributions



# SPOT LINE

linear inset

**EN** Linear light inset made of plastic; light inset, incl. high power adapter + converter can be installed flexibly and without tools; flush with profile system; fitted with single LED light points; good glare reduction due to recessed light point plane; despite this increased efficiency through special lens technology; inserted lenses with medium or wide flood radiation characteristic; for use in schools, retail and offices; energy-efficient LEDs with very good colour rendering

**DE** Linear-Lichteinsatz aus Kunststoff; Lichteinsatz, inkl. High Power Adapter + Konverter, werkzeuglos einsetz- und verschiebbar; bündig im Profilsystem; bestückt mit LED Einzellichtpunkten; gute Entblendung durch zurückversetzte Lichtpunktebene; trotzdem erhöhte Effizienz durch spezielle Linsentechnik; eingesetzte Linsen mit medium oder wide flood Strahlungscharakteristik; für den Einsatz in Schulen, Retail- und im Bürobereich; energieeffiziente LEDs mit sehr guter Farbwiedergabe

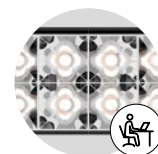

DIN EN 12464-1  
 UGR  $\leq$  16



up to 179 lm/W  
 (high efficiency)

## Order options

### COLOUR TEMPERATURE

2700 K CRI ≥ 90	9
3000 K CRI ≥ 90	0
3500 K CRI ≥ 90	2
4000 K CRI ≥ 90	1
2700 K CRI ≥ 80	4
3000 K CRI ≥ 80	5
3500 K CRI ≥ 80	7
4000 K CRI ≥ 80	6

### CONTROL

DALI-2

### LIGHT OPTIC

medium 28°	M
wide flood 67°	W

### MATERIAL COLOUR

traffic white RAL 9016	7
jet black RAL 9005	8
gold	9

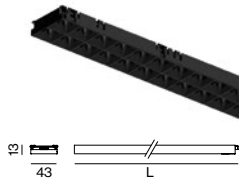

## SPOT LINE inset



UGR  
≤ 16

cd/m<sup>2</sup>  
≤ 1500

CRI  
≥ 90

1ADDR.

220-240V

X-PERT

X-PERT

### SPOT LINE

SYSTEM POWER	COLOUR TEMP.	LUM. FLUX	L (mm)	ORDER CODE
16.7W	2700K	2460lm	1000	0 8 6 - 6 3 1 0
	3000K	2460lm		
	3500K	2630lm		
	4000K	2800lm		
25.1W	2700K	3700lm	1500	0 8 6 - 6 3 2 0
	3000K	3700lm		
	3500K	3950lm		
	4000K	4210lm		
33W	2700K	4930lm	2000	0 8 6 - 6 3 3 0
	3000K	4930lm		
	3500K	5270lm		
	4000K	5610lm		
41W	2700K	6160lm	2500	0 8 6 - 6 3 4 0
	3000K	6160lm		
	3500K	6580lm		
	4000K	7010lm		
47W	2700K	7390lm	3000	0 8 6 - 6 3 5 0
	3000K	7390lm		
	3500K	7900lm		
	4000K	8410lm		

**Quickinfo**

2700 K, 3000 K, 3500 K, 4000 K  
 CRI ≥ 80, CRI ≥ 90, 3 SDCM  
 up to 150 lm/W  
 up to 2350 lm/m  
 L90 @ 50000h  
 DALI-2

**Types**

opal

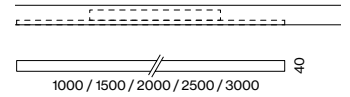
**Colours****Light distribution**

opal

**OPAL**

linear inset

**EN** Linear light inset made of plastic; light inset, incl. high power adapter + converter can be installed flexibly and without tools; flush with profile system; equipped with specially computed lenses; homogeneously illuminated, satinised PMMA cover; energy-efficient LEDs with very good colour rendering; energy-efficient LEDs with very good colour rendering

**DE** Linear-Lichteinsatz aus Kunststoff; Lichteinsatz, inkl. High Power Adapter + Konverter, werkzeuglos einsetz- und verschiebbar; bündig im Profilsystem; bestückt mit speziell berechneten Linsen; homogen ausgeleuchtete, satinierte PMMA-Abdeckung; energieeffiziente LEDs mit sehr guter Farbwiedergabe; energieeffiziente LEDs mit sehr guter Farbwiedergabe

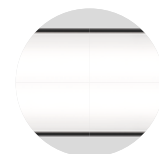

continuous  
cover



up to 150 lm/W  
(high efficiency)

## Order options

### COLOUR TEMPERATURE

2700 K CRI ≥ 90	9
3000 K CRI ≥ 90	0
3500 K CRI ≥ 90	2
4000 K CRI ≥ 90	1
2700 K CRI ≥ 80	4
3000 K CRI ≥ 80	5
3500 K CRI ≥ 80	7
4000 K CRI ≥ 80	6

### CONTROL

DALI-2

### LIGHT OPTIC

opal

### MATERIAL COLOUR

<input type="radio"/> traffic white RAL 9016	7
<input checked="" type="radio"/> jet black RAL 9005	8
transparent	0

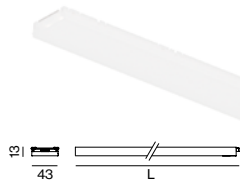
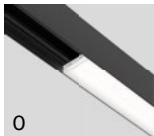
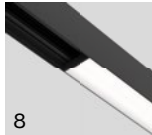

## OPAL inset

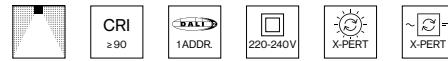

### OPAL HIGH PERFORMANCE

SYSTEM POWER	COLOUR TEMP.	LUM. FLUX	L (mm)	ORDER CODE
16.3W	3000K	2060lm	1000	0 8 6 - 6 1 1 0 :: 300
	4000K	2350lm		
24.5W	3000K	3090lm	1500	0 8 6 - 6 1 2 0 :: 300
	4000K	3520lm		
32.7W	3000K	4120lm	2000	0 8 6 - 6 1 3 0 :: 300
	4000K	4700lm		
41W	3000K	5160lm	2500	0 8 6 - 6 1 4 0 :: 300
	4000K	5870lm		
46W	3000K	6190lm	3000	0 8 6 - 6 1 5 0 :: 300
	4000K	7040lm		

## Accessories

### END CAPS

TYPE	ORDER CODE
end caps pair for opal	0 8 6 - 6 0 9 1 1 1

### COVER

TYPE	L (mm)	ORDER CODE
continuous opal cover	6000	0 8 6 - 6 0 8 0 6 0 0 0
continuous opal cover	25000	0 8 6 - 6 0 8 2 5 0 0 0
opal cover	1000	0 8 6 - 6 0 1 0 0 0 0 0
opal cover	1500	0 8 6 - 6 0 2 0 0 0 0 0
opal cover	2000	0 8 6 - 6 0 3 0 0 0 0 0
opal cover	2500	0 8 6 - 6 0 4 0 0 0 0 0
opal cover	3000	0 8 6 - 6 0 5 0 0 0 0 0



**Quickinfo**

2700 K, 3000 K, 3500 K, 4000 K  
 CRI ≥ 80, CRI ≥ 90, 3 SDCM  
 UGR ≤ 19  
 up to 166 lm/W  
 up to 2570 lm/m  
 L90 @ 50 000 h  
 DALI-2

**Types**

microprismatic

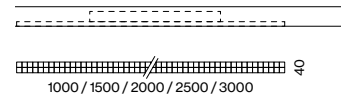

**Colours**



**Light distribution**



**MICROPRISMATIC**

linear inset

**EN** Linear light inset made of plastic; light inset, incl. high power adapter + converter can be installed flexibly and without tools; flush with profile system; completely homogeneously illuminated, microprismatic PMMA cover; for use in offices; energy-efficient LEDs with very good colour rendering

**DE** Linear-Lichteinsatz aus Kunststoff; Lichteinsatz, inkl. High Power Adapter + Konverter, werkzeuglos einsetz- und verschiebbar; bündig im Profilsystem; absolut homogen ausgeleuchtete, mikroprismatische PMMA-Abdeckung; für den Einsatz im Bürobereich; energieeffiziente LEDs mit sehr guter Farbwiedergabe

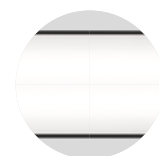

continuous cover



up to 166 lm/W (high efficiency)

## Order options

### COLOUR TEMPERATURE

2700 K CRI ≥ 90	9
3000 K CRI ≥ 90	0
3500 K CRI ≥ 90	2
4000 K CRI ≥ 90	1
2700 K CRI ≥ 80	4
3000 K CRI ≥ 80	5
3500 K CRI ≥ 80	7
4000 K CRI ≥ 80	6

### CONTROL

DALI-2

### LIGHT OPTIC

microprismatic

### MATERIAL COLOUR

<input type="radio"/> traffic white RAL 9016	7
<input checked="" type="radio"/> jet black RAL 9005	8
transparent	0

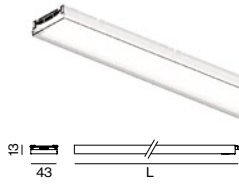
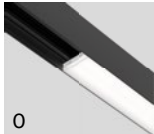
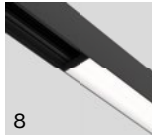

## MICROPRISMATIC inset



### MICROPRISMATIC

SYSTEM POWER	COLOUR TEMP.	LUM. FLUX	L (mm)	ORDER CODE
16.3W	3000K	2250lm	1000	0 8 6 - 6 2 1 0 :: 30 P
	4000K	2570lm		
24.5W	3000K	3380lm	1500	0 8 6 - 6 2 2 0 :: 30 P
	4000K	3850lm		
32.7W	3000K	4510lm	2000	0 8 6 - 6 2 3 0 :: 30 P
	4000K	5130lm		
41W	3000K	5630lm	2500	0 8 6 - 6 2 4 0 :: 30 P
	4000K	6420lm		
46W	3000K	6760lm	3000	0 8 6 - 6 2 5 0 :: 30 P
	4000K	7700lm		

## Accessories

### END CAPS

TYPE	ORDER CODE
end caps pair for microprismatic	0 8 6 - 6 0 9 1 2 1

### COVER

TYPE	L (mm)	ORDER CODE
continuous microprismatic cover	6000	0 8 6 - 6 0 8 0 6 0 0 P
continuous microprismatic cover	25000	0 8 6 - 6 0 8 2 5 0 0 P
microprismatic cover	1000	0 8 6 - 6 0 1 0 0 0 0 P
microprismatic cover	1500	0 8 6 - 6 0 2 0 0 0 0 P
microprismatic cover	2000	0 8 6 - 6 0 3 0 0 0 0 P
microprismatic cover	2500	0 8 6 - 6 0 4 0 0 0 0 P
microprismatic cover	3000	0 8 6 - 6 0 5 0 0 0 0 P

**Quickinfo**

3000 K, 4000 K  
 CRI ≥ 80, 3 SDCM  
 up to 162 lm/W  
 up to 3380 lm/m  
 non DIM, DALI-2

**Types**

indirect

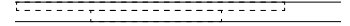

low power: 1500 / 3000 / 4500  
 high power: 1000 / 2000

**Colour****Light distribution**

indirect

**INDIRECT**

linear inset

**EN** Linear light inset made of plastic; light inset, incl. high power adapter + converter can be installed flexibly and without tools; flush with profile system; with indirect light component for additional accentuation of the ceiling; high quality lens system for maximum, homogeneous ceiling illumination; energy-efficient LEDs with very good colour rendering

**DE** Linear-Lichteinsatz aus Kunststoff; Lichteinsatz, inkl. High Power Adapter + Konverter, werkzeuglos einsetz- und verschiebbar; bündig im Profilsystem; mit indirekter Lichtkomponente für zusätzliche Akzentuierung der Decke; hochwertige Linsenoptik für maximale, homogene Deckenaufhellung; energieeffiziente LEDs mit sehr guter Farbwiedergabe

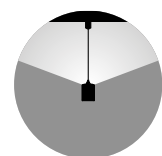

170° indirect  
 illumination

### Order options

COLOUR TEMPERATURE	
2700 K CRI ≥ 80	4
3000 K CRI ≥ 80	5
3500 K CRI ≥ 80	7
4000 K CRI ≥ 80	6

**CONTROL**  
 DALI-2

**LIGHT OPTIC**  
 batwing

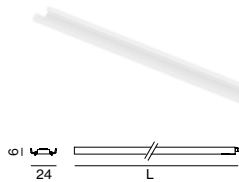

### INDIRECT inset



#### INDIRECT BATWING LOW POWER

SYSTEM POWER	COLOUR TEMP.	LUM. FLUX	L (mm)	ORDER CODE
16.6W	2700K	2240lm	1500	0 8 6 - 6 8 2 0 :: 30 B
	3000K	2240lm		
	3500K	2400lm		
	4000K	2550lm		
32W	2700K	4480lm	3000	0 8 6 - 6 8 5 0 :: 30 B
	3000K	4480lm		
	3500K	4790lm		
	4000K	5100lm		
47W	2700K	6720lm	4500	0 8 6 - 6 8 8 0 :: 30 B
	3000K	6720lm		
	3500K	7190lm		
	4000K	7650lm		

#### INDIRECT BATWING HIGH POWER

SYSTEM POWER	COLOUR TEMP.	LUM. FLUX	L (mm)	ORDER CODE
22.2W	2700K	2990lm	1000	0 8 6 - 6 8 1 5 :: 30 B
	3000K	2990lm		
	3500K	3190lm		
	4000K	3400lm		
43W	2700K	5980lm	2000	0 8 6 - 6 8 3 5 :: 30 B
	3000K	5980lm		
	3500K	6390lm		
	4000K	6800lm		

### Accessories

#### INDIRECT EXTENSION

SYSTEM POWER	COLOUR TEMP.	LUM. FLUX	L (mm)	ORDER CODE
2.6W low power	2700K	374lm	250	0 8 6 - 6 8 0 0 :: 30 B
	3000K	374lm		
	3500K	399lm		
	4000K	425lm		
5.4W high power	2700K	747lm	250	0 8 6 - 6 8 0 5 :: 30 B
	3000K	747lm		
	3500K	799lm		
	4000K	850lm		

max. inset length per driver: low power 4500mm, high power 2000mm without power supply

### Example for extension

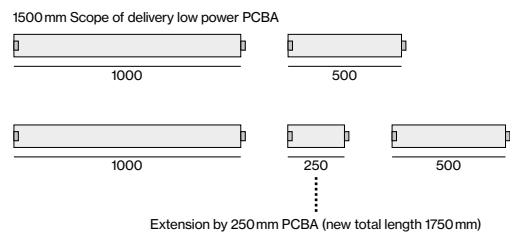



## NOBA

decorative inset

**EN** Decorative pendant light inset made of aluminium; choice of single lamp, double lamps or triple lamp; light inset, incl. high power adapter + converter can be installed flexibly and without tools; surface polished chrome, brushed aluminium or powder coated; pendant fitting with suspension, incl. feed (black); can be individually shortened; high quality plano-convex glass lens; no multiple shadows; energy-efficient LEDs with very good colour rendering; ceiling mounting rings for multiple positioning of the luminaire in the room available as accessory

**DE** Dekorativer Pendelleuchten-Lichteinsatz aus Aluminium; wahlweise ein-, zwei- oder dreiflämmig; Lichteinsatz, inkl. High Power Adapter + Konverter, werkzeuglos einsetz- und verschiebbar; Oberfläche chrom poliert, Aluminium gebürstet oder pulverbeschichtet; abgependelt mit Pendelabhängung, inkl. Einspeiseleitung (schwarz); beliebig kürzbar; hochwertige plan-konvexe Glaslinse; keine Mehrfachschatten; energieeffiziente LEDs mit sehr guter Farbwiedergabe; Deckenmontageringe für multiple Positionierung der Leuchte im Raum als Zubehör erhältlich

### Quickinfo

2700 K, 3000 K, 3500 K, 4000 K  
 CRI ≥ 90, 2 SDCM  
 up to 109 lm/W  
 L80 @ 50 000 h  
 DALI-2

### Types

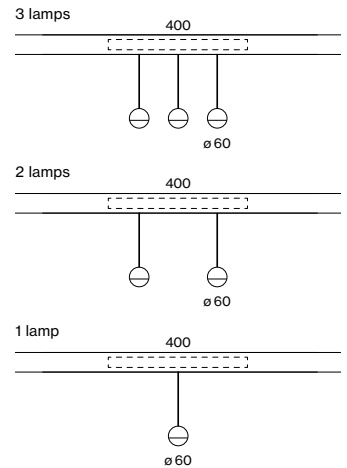

### Colours



### Light distribution



direct

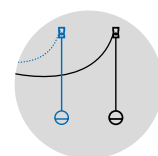

free positioning  
by cable and hook



high quality  
glass lens

### Order options

#### MOUNTING

suspension 2000 mm

#### COLOUR TEMPERATURE

2700K	9
3000K	0
3500K	2
4000K	1

#### CONTROL

DALI-2

#### MATERIAL COLOUR

<input type="checkbox"/> traffic white RAL 9016	7
<input checked="" type="checkbox"/> jet black RAL 9005	8
<input type="checkbox"/> brushed aluminium	6
<input type="checkbox"/> chrome	4
<input type="checkbox"/> gun metal	5
<input type="checkbox"/> brushed brass	3
<input type="checkbox"/> rose gold	9

#### MATERIAL COLOUR

#### ACCESSORIES / DRIVER

<input type="checkbox"/> traffic white RAL 9016	7
<input checked="" type="checkbox"/> jet black RAL 9005	8

#### BEAM ANGLE

wide flood 67°

### NOBA 60

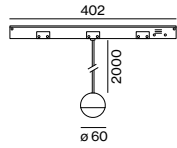

#### DOWNLIGHT 1 LAMP

INSET POWER	COLOUR TEMP.	LUMINOUS FLUX	ORDER CODE
10 W	2700 K	930 lm	086-711003
	3000 K	986 lm	086-711004
	3500 K	982 lm	086-711005
	4000 K	1040 lm	086-711006

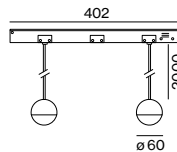

#### DOWNLIGHT 2 LAMPS

INSET POWER	COLOUR TEMP.	LUMINOUS FLUX	ORDER CODE
19.2 W	2700 K	1860 lm	086-711103
	3000 K	1970 lm	086-711104
	3500 K	1960 lm	086-711105
	4000 K	2090 lm	086-711106

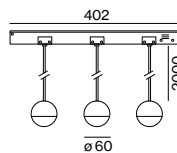
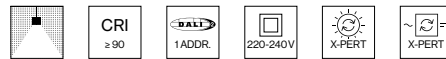

#### DOWNLIGHT 3 LAMPS

INSET POWER	COLOUR TEMP.	LUMINOUS FLUX	ORDER CODE
28.8 W	2700 K	2790 lm	086-712003
	3000 K	2960 lm	086-712004
	3500 K	2950 lm	086-712005
	4000 K	3130 lm	086-712006

### Mounting accessories



#### HOOK ceiling mounted

TYPE	Ø-H (mm)	ORDER CODE
hook	16-30	030-100001



DESIGN  
AWARD  
2024

## ARY

decorative inset

**EN** Decorative pendant light inset made of aluminium; choice of single lamp, double lamps or triple lamp; light inset, incl. high power adapter + converter can be installed flexibly and without tools; surface powder coated; pendant fitting with suspension, incl. feed (black or white); can be individually shortened; good glare reduction due to recessed light point plane; incl. high quality lens system; precise radiation characteristics with different beam angles; shades available as accessory in RAL colours velvet beige, madeira brown, kingfisher grey, woodpecker olive, signal white or signal black; COB (Chip on Board) technology for maximum efficiency; no multiple shadows; energy-efficient LEDs with very good colour rendering; ceiling mounting rings for multiple positioning of the luminaire in the room available as accessory

**DE** Dekorativer Pendelleuchten-Lichteinsatz aus Aluminium; wahlweise ein-, zwei- oder dreiflammig; Lichteinsatz, inkl. High Power Adapter + Konverter, werkzeuglos einsetz- und verschiebbar; Oberfläche pulverbeschichtet; abgependelt mit Pendelabhängung, inkl. Einspeiseleitung (schwarz oder weiß); beliebig kürzbar; gute Entblendung durch zurückversetzte Lichtpunktebene; inkl. hochwertiger Linsenoptik; präzise Abstrahlcharakteristik mit verschiedenen Ausstrahlwinkeln; Shades in den RAL Farben velvet beige, madeira brown, kingfisher grey, woodpecker olive, signal white oder signal black als Zubehör erhältlich; mit COB (Chip on Board) Technologie für höchste Effizienz; keine Mehrfachschatten; energieeffiziente LEDs mit sehr guter Farbwiedergabe; Deckenmontageringe für multiple Positionierung der Leuchte im Raum als Zubehör erhältlich

### Quickinfo

2700 K, 3000 K, 3500 K, 4000 K  
CRI ≥ 90, 3 SDCM  
up to 114 lm/W  
L90 @ 50 000 h  
non DIM, DALI-2

### Types

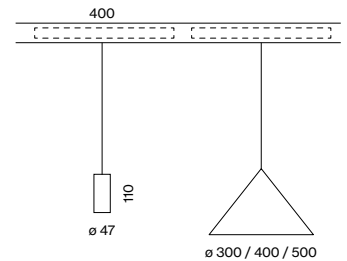

### Colours



### Light distributions

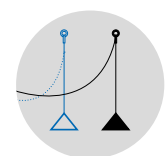

free positioning  
by ring and hook

## Order options

### MOUNTING

suspension 2000 mm

### COLOUR TEMPERATURE

2700K	9
3000K	0
3500K	2
4000K	1

### CONTROL

DALI-2

### MATERIAL COLOUR

<input type="radio"/> traffic white RAL 9016	7
<input checked="" type="radio"/> jet black RAL 9005	8
<input type="radio"/> special colours*	X

\*cable and driver always in black

### MATERIAL COLOUR

#### ACCESSORIES / DRIVER

<input type="radio"/> traffic white RAL 9016	7
<input checked="" type="radio"/> jet black RAL 9005	8

### BEAM ANGLE

medium 25°	M
flood 44°	F

### SHADE COLOUR

<input type="checkbox"/> velvet beige RAL 085 8010	C
<input type="checkbox"/> madeira brown RAL 050 40 40	T
<input type="checkbox"/> kingfisher grey RAL 230 60 10	L
<input type="checkbox"/> woodpecker olive RAL 10 50 20	G
<input type="checkbox"/> signal white RAL 9003	W
<input type="checkbox"/> signal black RAL 9004	B

## ARY

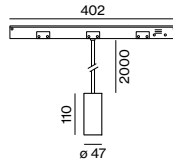

### DOWNLIGHT 1 LAMP

INSET POWER	COLOUR TEMP.	LUMINOUS FLUX	ORDER CODE
14.1W	2700K	1390lm	086-7300::3■▲
	3000K	1450lm	
	3500K	1520lm	
	4000K	1560lm	

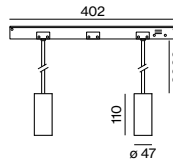
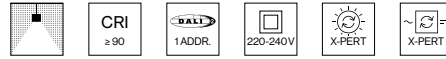

### DOWNLIGHT 2 LAMPS

INSET POWER	COLOUR TEMP.	LUMINOUS FLUX	ORDER CODE
28.2W	2700K	2780lm	086-7310::3■▲
	3000K	2910lm	
	3500K	3040lm	
	4000K	3130lm	

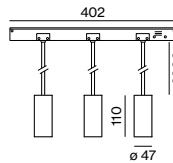

### DOWNLIGHT 3 LAMPS

INSET POWER	COLOUR TEMP.	LUMINOUS FLUX	ORDER CODE
41W	2700K	4170lm	086-7320::3■▲
	3000K	4360lm	
	3500K	4560lm	
	4000K	4690lm	

## Mounting accessories



TYPE	Ø-H (mm)	ORDER CODE
ring ceiling mounted	50-88	050-051021■
hook	18-58	050-051031■

## Optical accessories

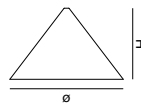

### SHADE

TYPE	Ø-H (mm)	ORDER CODE
cone 300	300-188	049-593311□
cone 400	400-253	049-593411□
cone 500	500-318	049-593511□

only for one lamp

LUMINOUS FLUX value calculated for medium



**Quickinfo**

sensor  
 ESSENTIAL, SENSE  
 DALI-2

**Type**

sensor



41

**Inset colours****Sensors**

essen- sense  
 tial

**SENSOR**

inset

<sup>EN</sup> Sensor inset; choice of ESSENTIAL or SENSE; ESSENTIAL: brightness and presence sensor; SENSE: brightness, presence, temperature, humidity, air quality and noise level sensor; flush with profile system

<sup>DE</sup> Sensor-Einsatz; wahlweise ESSENTIAL oder SENSE; ESSENTIAL: Helligkeits- und Anwesenheitssensor; SENSE: Helligkeits-, Anwesenheits-, Temperatur-, Luftfeuchtigkeits-, Luftqualitäts- und Lärmpegelsensor; bündig im Profilsystem

### Order options

#### CONTROL

\_\_\_\_\_  
DALI-2

#### INSET COLOUR



○ traffic white RAL 9016      7

● jet black RAL 9005      8

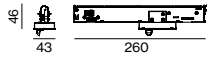

### SENSOR inset



#### ESSENTIAL SENSOR

**TYPE**  
brightness & presence

**ORDER CODE**  
0 8 6 - 5 2 1 8 1 1



#### SENSE SENSOR

**TYPE**  
brightness, presence, temperature,  
sound pressure, humidity, CO<sub>2</sub>

**ORDER CODE**  
0 8 6 - 5 2 1 8 1 2